

SQ, SQE

US Installation and operating instructions



LIMITED WARRANTY

Products manufactured by GRUNDFOS PUMPS CORPORATION (Grundfos) are warranted to the original user only to be free of defects in material and workmanship for a period of 24 months from date of installation, but not more than 30 months from date of manufacture. Grundfos' liability under this warranty shall be limited to repairing or replacing at Grundfos' option, without charge, F.O.B. Grundfos' factory or authorized service station, any product of Grundfos' manufacture. Grundfos will not be liable for any costs of removal, installation, transportation, or any other charges which may arise in connection with a warranty claim. Products which are sold but not manufactured by Grundfos are subject to the warranty provided by the manufacturer of said products and not by Grundfos' warranty. Grundfos will not be liable for damage or wear to products caused by abnormal operating conditions, accident, abuse, misuse, unauthorized alteration or repair, or if the product was not installed in accordance with Grundfos' printed installation and operating instructions.

To obtain service under this warranty, the defective product must be returned to the distributor or dealer of Grundfos' products from which it was purchased together with proof of purchase and installation date, failure date, and supporting installation data. Unless otherwise provided, the distributor or dealer will contact Grundfos or an authorized service station for instructions. Any defective product to be returned to Grundfos or a service station must be sent freight prepaid; documentation supporting the warranty claim and/or a Return Material Authorization must be included if so instructed.

GRUNDFOS WILL NOT BE LIABLE FOR ANY INCIDENTAL OR CONSEQUENTIAL DAMAGES, LOSSES, OR EXPENSES ARISING FROM INSTALLATION, USE, OR ANY OTHER CAUSES. THERE ARE NO EXPRESS OR IMPLIED WARRANTIES, INCLUDING MERCHANTABILITY OR FITNESS FOR A PARTICULAR PURPOSE, WHICH EXTEND BEYOND THOSE WARRANTIES DESCRIBED OR REFERRED TO ABOVE.

Some jurisdictions do not allow the exclusion or limitation of incidental or consequential damages and some jurisdictions do not allow limit actions on how long implied warranties may last. Therefore, the above limitations or exclusions may not apply to you. This warranty gives you specific legal rights and you may also have other rights which vary from jurisdiction to jurisdiction.

SQ, SQE

Installation and
operating instructions

Page 4



CONTENTS

US

1. General description	4
1.1 Applications	4
2. Preinstallation	4
2.1 Well preparation	4
2.2 Make sure you have the right pump	4
2.3 Pumped liquid requirements	4
2.4 Motor cooling requirements	5
2.5 Liquid temperatures/cooling	5
2.6 Motor preparation	5
2.7 Refilling of motor liquid	5
3. Installation positions	6
3.1 Positional requirements	6
4. Electrical connection	6
4.1 General	6
4.2 Motor protection	6
4.3 Connection of motor	6
5. Cable sizing	7
6. Splicing the cable	7
7. Fitting the cable plug to the motor	7
8. Fitting the cable guard	8
9. Piping	8
10. Installing the pump	9
10.1 Installation depth	9
11. Generator operation	9
12. Starting the pump for the first time	10
12.1 Motor cooling and other considerations	10
12.2 Impurities in the water	10
12.3 Minimum flow rate	10
12.4 Built-in protection	10
12.5 Resetting the pump	10
12.6 MS 3 motors	10
12.7 MSE 3 motors	10
12.8 Maintenance and service	10
13. Assembly of pump and motor	11
14. Troubleshooting	12
14.1 Instruments not allowed	13
15. Checking of motor and cable	13
16. Environment	13
17. Disposal	13
18. Technical data	14



Before beginning installation procedures, these installation and operating instructions should be studied carefully. The installation and operation should also be in accordance with local regulations and accepted codes of good practice.

1. General description

The SQ/SQE is a 3 inch diameter submersible pump mainly designed for the pumping of raw water in domestic water supply. This manual is designed to assist in the proper set-up, installation and operation of these pumps.

1.1 Applications

Typical applications are:

- residential housing
- small waterworks
- pressure boosting
- irrigation systems
- liquid transfer in tanks.

2. Preinstallation

2.1 Well preparation

If the pump is to be installed in a new well, the well should be fully developed and bailed or blown free of cuttings and sand.

The construction of the Grundfos SQ/SQE submersibles makes them resistant to abrasion; however, no pump made of any material can forever withstand the destructive wear that occurs when constantly pumping sandy water.

If this pump is used to replace an oil-filled submersible or oil-lubricated line-shaft turbine in an existing well, the well must be blown or bailed clear of oil.

2.2 Make sure you have the right pump

Determine the maximum depth of the well and the drawdown level at the maximum pump capacity. Pump selection and setting depth should be made based on this data.

2.3 Pumped liquid requirements

Submersible well pumps are designed for pumping clear, cold water; free of air or gases. Decreased pump performance and life expectancy can occur if the water is not clear, cold or contains air or gases.

The water temperature should not exceed 104°F.

A check should be made to ensure that the installation depth of the pump will always be at least three feet below the maximum drawdown level of the well. The bottom of the motor should never be installed lower than the top of the well screen or within five feet of the well bottom.

2.4 Motor cooling requirements

To ensure proper motor cooling, refer to the table below for minimum flow requirements:

Flow velocity past the motor	Maximum liquid temperature
0.0 f/s (free convection)	86°F (30°C)
Min. 0.5 f/s	104°F (40°C)

If the pump is to be installed horizontally, e.g. in a tank, and there is a risk that the pump might be covered by mud, it must be installed in a flow sleeve.

2.5 Liquid temperatures/cooling

Figure 1 shows an SQ/SQE pump installed in a well. With the pump operating, figure 1 illustrates the following:

- Well diameter
- Pump diameter
- Temperature of pumped liquid
- Flow past the motor to the pump suction strainer.

Note: The well diameter must be at least 3 inches. If there is a risk that the motor will be covered with sediment, it is recommended the pump be placed in a flow sleeve. The motor should always be installed above the well screen.

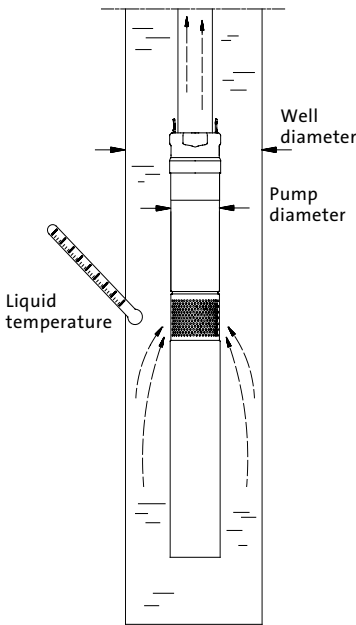

Fig. 1 Pump installed in well

TM01 0518 1297

2.6 Motor preparation

Grundfos MS 3 and MSE 3 submersible motors have water-lubricated slide bearings. No additional lubrication is required.

The submersible motors are factory-filled with a special Grundfos motor liquid, type SML 2, which will protect the motor liquid down to 4°F (-20°C) and prevent the growth of bacteria. The level of motor liquid is important for the operating life of the bearings and consequently the life of the motor.



2.7 Refilling of motor liquid

If for any reason the motor liquid has been drained or lost, the motor must be refilled with Grundfos motor liquid SML 2.

To refill the motor, proceed as follows:

1. Remove the cable guard and separate the pump end from the motor.
2. Place the motor in vertical position with an inclination of approximately 10°.
3. Remove the filling plug using a screwdriver or a similar tool.
4. Inject motor liquid into the motor with a filling syringe or similar tool, see fig. 2.
5. To allow possible air to escape, move the motor from side to side and turn the shaft.
6. Replace the filling plug and make sure it is tight.
7. Assemble pump end and motor.
8. Fit the cable guard.

The pump is now ready for installation.

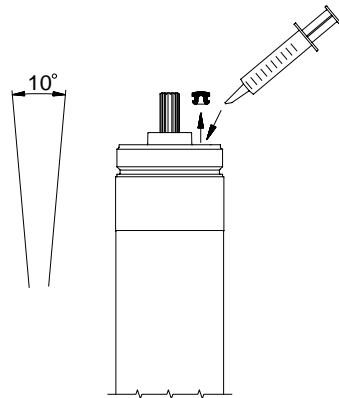

Fig. 2 Injecting motor liquid

TM02 9606 3504

3. Installation positions

3.1 Positional requirements

The pump is suitable for vertical as well as horizontal installation, however, the pump shaft must never fall below the horizontal plane, see fig. 3.

If the pump is to be installed horizontally, e.g. in a tank, and there is a risk that the pump might be covered by mud, it must be installed in a flow sleeve.

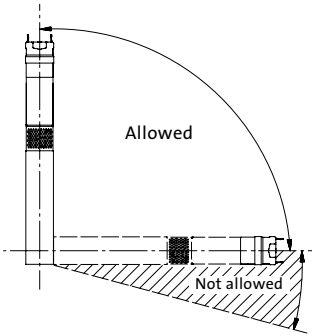

Fig. 3 Pump position

TM01 1375 4397

4. Electrical connection

4.1 General

The electrical connection should be carried out by an authorized electrician in accordance with local regulations.



Before starting work on the pump, make sure that the electricity supply has been switched off and that it cannot be accidentally switched on.

The pump must be grounded.

The pump must be connected to an external mains switch.

The supply voltage, rated maximum current and power factor (PF) appear on the motor nameplate.

The required voltage for Grundfos submersible MS 3/MSE 3 motors, measured at the motor terminals, is $-10\%/+6\%$ of the nominal voltage during continuous operation (including variation in the supply voltage and losses in cables).

If the pump is connected to an installation where a Ground Fault circuit breaker (GFI) is used as additional protection, this circuit breaker must trip out when ground fault currents with DC content (pulsating DC) occur.

Note: The pump must never be connected to a capacitor or to another type of control box than CU 300 or CU 301.

Note: The pump must never be connected to an external frequency converter.

Supply voltage:

1 x 90-120 V or 1 x 200-240 V $-10\%/+6\%$, 50/60 Hz.

The current consumption can only be measured accurately by means of a true RMS instrument. If other instruments are used, the value measured will differ from the actual value.

The SQE pumps can be connected to a CU 300 or CU 301 control box.

4.2 Motor protection

The motor has built-in automatic thermal overload protection and requires no additional motor protection.

4.3 Connection of motor

The motor can be connected directly to the main circuit breaker.

Start/stop of the pump will typically be done via a pressure switch, see fig. 4.

Note: The pressure switch must be rated for the maximum amps of the specific pump.



Reduced risk of electric shock during operation of this pump requires the provision of acceptable grounding. If the means of connection to the supply connected box is other than grounded metal conduit, ground the pump back to the service by connecting a copper conductor, at least the size of the circuit supplying the pump.

Single-phase 2-wire wiring diagram for Grundfos motors

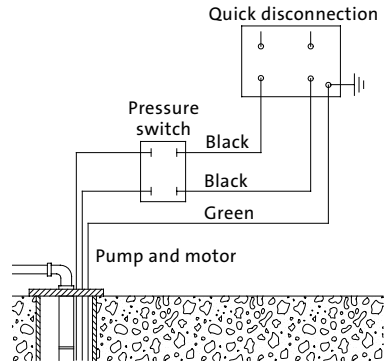

Fig. 4 Wiring diagram

Note: The pump must never be connected to a capacitor or to another type of control box than CU 300 or CU 301.

TM02 8736 0804

5. Cable sizing

Single-phase 60 Hz maximum cable length motor service to entrance:

Motor rating		Copper wire size								
Volts	hp	14	12	10	8	6	4	2	0	00
115	0.5	65	100	160	260	410	660	1050	1680	
230	0.5	300	480	760	1210	1930	3060	4870		
230	0.75	190	300	470	750	1190	1890	3010	4800	
230	1.0	140	220	350	560	890	1420	2260	3600	4540
230	1.5	130	210	330	520	830	1320	2110	3360	4230

US

6. Splicing the cable

Splice the drop cable with the motor cable. If the splice is carefully made, it will be as efficient as any other portion of the cable and will be completely watertight.

There are a number of cable splicing kits available today - epoxy-filled, rubber-sealed, etc. Many perform well if the manufacturer's directions are followed carefully. If one of these kits is not used, we recommend the following method for splicing the motor cable to the drop cable:

1. Examine the motor cable and the drop cable carefully for damage.
2. Cut the motor leads off in a staggered manner.
3. Cut the ends of the drop cable so that the ends match up with the motor leads.
Be sure to match the colors.
4. Strip back and strip off one inch of insulation from each lead, making sure to scrape the wire bare to obtain a good connection.
Be careful not to damage the copper conductor when stripping off the insulation.
5. Insert a properly sized Sta-Kon™-type connector on each pair of leads, again making sure that colors are matched.
Using Sta-Kon™ crimping pliers, indent the lugs.
Be sure to squeeze down hard on the pliers, particularly when using large cable.
6. Form a piece of electrical putty tightly around each Sta-Kon™. The putty should overlap on the insulation of the wire.
7. Use a good quality tape such as #33 Scotch Waterproof or Plymouth Rubber Company Slipknot Grey. **Wrap each wire and joint tightly for a distance of about 2½ inches on each side of the joint. Make a minimum of four passes over each joint and overlap each pass approximately one inch to ensure a completely watertight seal.**

Note: Do not lower or lift the pump using the motor cable.

7. Fitting the cable plug to the motor

The cable plug supplied with the motor is factory-greased. Check that the plug is greased correctly, see fig. 5.

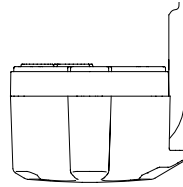

TM02.9604.3504

Fig. 5 Greasing of plug

To fit the cable plug, proceed as follows:

1. Check that the cable is of the correct type, cross-section and length.
2. Check that the mains on the location has correct connection to ground.
3. Check that the motor socket is clean and dry.
4. Press the cable plug onto the motor socket. The plug will only fit one way, see fig. 6.
5. Fit and tighten the four screws, see fig. 6.
When the plug has been fitted, there must not be a clearance between the motor and the cable plug.

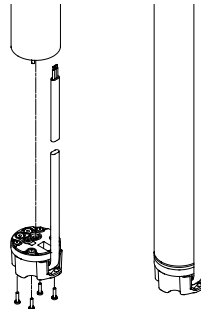

TM02.9605.3504

Fig. 6 Fitting the cable plug

8. Fitting the cable guard

To fit the cable guard, proceed as follows:

1. Make sure that the motor lead lies flat in the cable guard.
2. Place the cable guard in the groove in the cable plug. The two flaps must engage with the upper edge of the pump sleeve, see fig. 7.

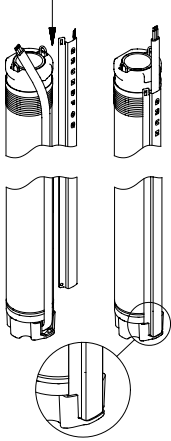

TM02 9613 3504

Fig. 7 Placing the cable guard

3. Fasten the cable guard to the pump suction strainer with the two self-tapping screws supplied, see fig. 8.

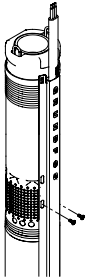

TM01 4427 0299

Fig. 8 Fitting the cable guard to the pump suction strainer

9. Piping

- The pump should only be gripped by the two flats at the top of the pump, see fig. 9.
- The pump can be installed vertically or horizontally. During operation, the pump must always be completely submerged in water.
- When plastic pipe is used, a stainless steel safety wire is recommended for lowering and lifting the pump. Fasten the wire to the eyelet on the pump, see fig. 10.
- The threaded joints must be well cut and fit together tightly to ensure that they do not work loose.

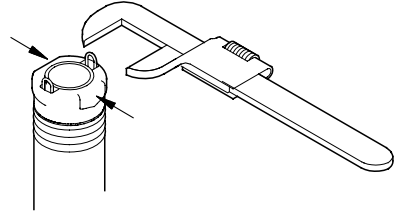

Fig. 9 Gripping the pump

TM02 8739 0804

10. Installing the pump

10.1 Installation depth

The dynamic water level should always be above the pump, see fig. 10.

A = Dynamic water level

B = Static water level

C = Minimum 3 inch well diameter

D = Drawdown

E = Installation depth below static water level.
Maximum 500 feet.

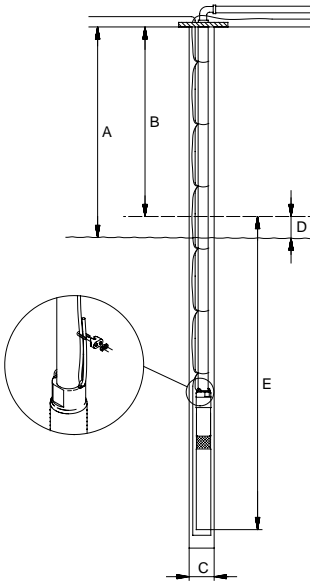

Fig. 10 Installation depth

Procedure:

To install the pump, proceed as follows:

1. Attach the enclosed data plate sticker at the well head.
2. Check the well for proper clearance. The well must be at least 3 inches in diameter. It is a good idea to check the well for clearance using a plumb ring (2.95 ϕ x 10 in.).
3. Attach the first section of riser pipe to the pump.
4. Lower the pump into the well. Make sure the motor cable is not damaged when the pump is lifted or lowered into the well, especially in 3 inch wells.
Note: Do not lower or lift the pump using the motor cable.

5. When the pump has been installed to the required depth, the installation should be finished by means of a well seal.
Note that the dynamic water level should always be above the pump.
6. Loosen the safety wire so that it becomes unloaded and lock it to the well seal using a cable clamp.
7. Complete the electrical connections.

Note: The pump must never be connected to a capacitor or to another type of control box than CU 300 or CU 301.

Installation depths:

Maximum installation depth:
500 feet below the static water level.

Minimum installation depth:
1.75 feet below the dynamic water level.

Vertical installation:

During start-up and operation, the pump must always be completely submerged in water.

Horizontal installation:

The pump must be installed at least 1.75 feet below the dynamic water level.

If there is a risk that the pump might be covered by mud, the pump must always be placed in a flow sleeve.

Note: Do not lower or lift the pump using the motor cable.

11. Generator operation

It is safe to operate the SQ/SQE with a generator.

The generator must be sized 50% above the P1 (input power) values of the pump. See the following table.

Motor [hp]	Min. generator size [W]	Recommended generator output [W]
0.5	1200	1500
0.75	1900	2500
1.0	2600	3200
1.5	2800	3500

TM02 8740 0804

12. Starting the pump for the first time

When the pump has been connected correctly, the pump should be started with the discharge valve closed approximately one third.

Due to the soft start feature, the pump takes approximately 2 seconds to develop full pressure.

12.1 Motor cooling and other considerations

- Make sure the well is capable of yielding a minimum quantity of water corresponding to the pump capacity.
- Do not start the pump until it is completely submerged in the liquid.
- As the valve is being opened, the drawdown should be checked to ensure that the pump always remains submerged.
- To ensure the necessary cooling of the motor, the pump should never be set so low that it gives no water.

If the flow rate suddenly falls, the reason might be that the pump is pumping more water than the well can yield. The pump must immediately be stopped and the fault corrected.

12.2 Impurities in the water

If there are impurities in the water, the valve should be opened gradually as the water becomes clearer. The pump should not be stopped until the water is clean, otherwise the pump parts and the check valve may become clogged.

When the water is clean, the valve should be fully opened.

12.3 Minimum flow rate

To ensure the necessary cooling of the motor, the pump flow rate should never be set to a value lower than 0.2 gpm.

If the flow rate suddenly falls, the reason might be that the pump is pumping more water than the well can yield. The pump must immediately be stopped and the fault corrected.

Note: The pump's dry-running protection is effective only within the recommended duty range of the pump.

Note: Do not let the pump run against a closed discharge valve for more than 5 minutes. When the discharge valve is closed, there is no cooling flow and there is a risk of overheating in motor and pump.

12.4 Built-in protection

The motor incorporates an electronic unit which protects the motor in various situations.

- In case of overload, the built-in overload protection will stop the pump for 5 minutes. After that period, the pump will attempt to restart.
- If the pump has been stopped as a result of dry running, it will start automatically after 5 minutes.
- If the pump is restarted and the well has not recovered, the pump will stop after 30 seconds.

12.5 Resetting the pump

Switch off the electricity supply for 1 minute.

The motor is protected against the following conditions:

- dry running
- voltage surges (up to 6000 V)
In areas with high lightning intensity, external lightning protection is required.
- overvoltage
- undervoltage
- overload
- overtemperature.

12.6 MS 3 motors

Note: All MS 3 motors are factory-set to detect dry-running conditions.

Check that the combination of pump and motor corresponds to the data on page 39.

12.7 MSE 3 motors

Note: All MSE 3 motors are factory-set to detect dry-running conditions. However, if the maximum pump speed setting is changed, the dry running stop value must also be changed. Please refer to either the CU 301 or CU 300 I&O for instructions on this procedure.

12.8 Maintenance and service

The pumps are normally maintenance-free.

Deposits and wear may occur. For that purpose, service kits and service tools are available from Grundfos.

The Grundfos Service Manual is available on request.

The pumps can be serviced at a Grundfos service center.

13. Assembly of pump and motor

To assemble pump end and motor, proceed as follows:

1. Place the motor horizontally in a vice and tighten it, see fig. 12.
2. Pull the pump shaft out to the position shown in fig. 11.

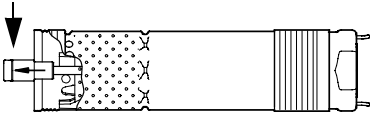

TM02 8425 5203

Fig. 11 Pump shaft position

3. Grease the motor shaft end with the grease supplied with the motor.
4. Screw the pump end on the motor (55 Nm).
Note: The pump shaft must engage with the motor shaft.
A spanner may be used on the clamping faces of the pump end, see fig. 12.
5. Fit the cable guard as described in section 8.

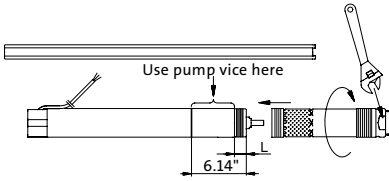

TM01 2854 3804

Fig. 12 Pump in vice

- 0.5 hp: L = 4.7".
- 0.75 hp: L = 4.0".
- 1.0 hp: L = 2.6".
- 1.5 hp: L = 2.6".

When pump end and motor have been assembled correctly, there must be no clearance between pump end and motor.

To disassemble, reverse procedure.

14. Troubleshooting

US

Fault	Cause	Remedy	
1. The pump does not run.	a) The fuses are blown.	Replace the blown fuses. If the new fuses blow too, check the electrical installation and the drop cable.	
	b) The GFI circuit breaker has tripped.	Reset the circuit breaker.	
	c) No electricity supply.	Contact the electricity provider.	
	d) The motor protection has cut off the electricity supply due to overload.	Check for motor/pump blockage.	
	e) The drop cable is defective.	Repair or replace the pump/cable.	
	f) Overvoltage has occurred.	Check the electricity supply.	
2. The pump runs but gives no water.	a) The discharge valve is closed.	Open the valve.	
	b) No water or too low water level in well.	Increase the installation depth of the pump, throttle the pump or replace it with a smaller capacity model.	
	c) The check valve is stuck in its closed position.	Pull the pump and clean or replace the valve.	
	d) The suction strainer is closed.	Pull the pump and clean the strainer.	
	e) The pump is defective.	Repair or replace the pump.	
3. The pump runs at reduced capacity.	a) The drawdown is larger than anticipated.	Increase the installation depth of the pump, throttle the pump or replace it with a smaller capacity model.	
	b) The valves in the discharge pipe are partly closed/blocked.	Check and clean or replace the valves as necessary.	
	c) The discharge pipe is partly choked by impurities (iron bacteria).	Clean or replace the discharge pipe.	
	d) The check valve of the pump is blocked.	Pull the pump and clean or replace the valve.	
	e) The pump and the riser pipe are partly choked by impurities (iron bacteria).	Pull the pump. Check and clean or replace the pump, if necessary. Clean the pipes.	
	f) The pump is defective.	Repair or replace the pump.	
	g) Hole in discharge pipe.	Check and repair the piping.	
	h) The riser pipe is defective.	Replace the riser pipe.	
	i) Undervoltage has occurred.	Check the electricity supply.	
	4. Frequent starts and stops.	a) The differential of the pressure switch between the start and stop pressures is too small.	Increase the differential. However, the stop pressure must not exceed the operating pressure of the pressure tank and the start pressure should be high enough to ensure sufficient water supply.
		b) The water level electrodes or level switches in the reservoir have not been installed correctly.	Adjust the intervals of the electrodes/level switches to ensure suitable time between the cutting-in and cutting-out of the pump. See installation and operating instructions for the automatic devices used. If the intervals between start/stop cannot be changed via the automatics, the pump capacity may be reduced by throttling the discharge valve.
c) The check valve is leaking or stuck half-open.		Pull the pump and clean or replace the check valve.	
d) The supply voltage is unstable.		Check the electricity supply.	
e) The motor temperature is too high.		Check the water temperature.	

14.1 Instruments not allowed

Note: The use of the following instruments is not allowed during troubleshooting.

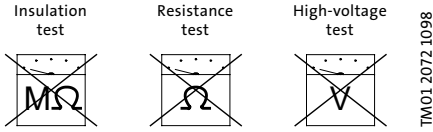
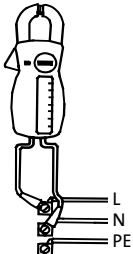
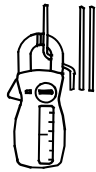

Fig. 13 Instruments not allowed

Note: When measuring, use RMS instruments.

15. Checking of motor and cable

<p>1. Supply voltage</p>  <p style="text-align: right; font-size: small;">TM00 1371 5092</p>	<p>Measure the voltage L1 (RMS) between phase and L2. Connect the voltmeter to the terminals at the connections.</p>	<p>The voltage should, when the motor is loaded, be within the range specified in section 4. <i>Electrical connection</i>. Large variations in supply voltage indicate poor electricity supply, and the pump should be stopped until the problem has been corrected.</p>
<p>2. Current consumption</p>  <p style="text-align: right; font-size: small;">TM00 1372 5082</p>	<p>Measure the current (RMS) while the pump is operating at a constant discharge head (if possible, at the capacity where the motor is most heavily loaded). For maximum current, see motor nameplate.</p>	<p>If the current exceeds the full-load current, there are the following possible faults:</p> <ul style="list-style-type: none"> • Poor connection in the leads, possibly in the cable joint. • Too low supply voltage, see item 1.

16. Environment

During handling, operation, storage and transport, all environment regulations dealing with the handling of hazardous materials must be observed.



When the pump is taken out of operation, it must be ensured that no hazardous material is left in the pump and in the riser pipe, which can be injurious to persons and the environment.

17. Disposal

Disposal of this product or parts of it must be carried out according to the following guidelines:

1. Use the local public or private waste collection service.
2. If such waste collection service does not exist or cannot handle the materials used in the product, please deliver the product or any hazardous materials from it to your nearest Grundfos company or service center.

18. Technical data

Supply voltage

1 x 90-120 V -10%/+6%, 50/60 Hz, PE.
1 x 200-240 V -10%/+6%, 50/60 Hz, PE.

Operation via generator

Recommended generator output must be equal to P1 [kW] + 50% and minimum P1 + 10%.

Starting current

The motor starting current is equal to the highest value stated on the motor nameplate.

Starting

Soft starting.

Run-up time

Maximum 2 seconds.

Motor protection

The motor is protected against dry running, overvoltage, undervoltage, overload and overtemperature.

Power factor

PF = 1.

Service factor

0.5 hp: 1.85 at 115 V/230 V.
0.75 hp: 2.05 at 230 V.
1.0 hp: 2.25 at 230 V.
1.5 hp: 1.65 at 230 V.

Motor cable

3 Wire, 14 AWG XLPE.
Length: 5 feet.

Motor liquid

Type SML 2.

pH values

5 to 9.

Liquid temperature

The temperature of the pumped liquid must not exceed 104°F.

Note: If liquids with a viscosity higher than that of water are to be pumped, please contact Grundfos.

Discharge port

5 SQ/SQE: 1" NPT.
10-15 SQ/SQE: 1½" NPT.
22-30 SQ/SQE: 1½" NPT.

Storage conditions

Minimum ambient temperature: 4°F.
Maximum ambient temperature: 140°F.

Freeze protection

Note: The motor must not be stored without being filled with motor liquid.

If the pump has to be stored after use, it must be stored on a frost-free location or it must be ensured that the motor liquid is frost-proof.

Operating conditions

Minimum ambient liquid temperature: 32°F.
Maximum ambient liquid temperature: 104°F.

Motor dimensions (MS 3 and MSE 3)

0.5 hp: 20.9" length x 2.68" diameter.
0.75 hp: 20.9" length x 2.68" diameter.
1.0 hp: 22.3" length x 2.68" diameter.
1.5 hp: 22.3" length x 2.68" diameter.

Motor weights (MS 3 and MSE 3)

0.5 hp: 6.0 lbs.
0.75 hp: 7.1 lbs.
1.0 hp: 8.2 lbs.
1.5 hp: 8.2 lbs.

Pump end dimensions

Pump diameter: 2.68".
Pump diameter, incl. cable guard: 2.91".

Pump end dimensions (min. and max.)

5 SQ/SQE: 10.6" to 18.0".
10 SQ/SQE: 10.6" to 14.8".
15 SQ/SQE: 10.6" to 16.9".
22 SQ/SQE: 10.6" to 16.9".
30 SQ/SQE: 10.6" to 13.7".

Pump end weights (min. and max.)

All SQ/SQE models: 2.2 lbs to 3.5 lbs.

Well diameter

Minimum 3".

Installation depth

Maximum 500 feet below static water level.

Subject to alterations.

Pump models

Pump type	Power P ₂ [hp]	Voltage [V]	Flow range [gpm]	Min. well dia.	Disch.
55Q/SQE-90	0.5	230/115	1.5-7.5	3"	1" NPT
55Q/SQE-140	0.5	230/115	1.5-7.5	3"	1" NPT
55Q/SQE-180	0.5	230/115	1.5-7.5	3"	1" NPT
55Q/SQE-230	0.75	230	1.5-7.5	3"	1" NPT
55Q/SQE-270	0.75	230	1.5-7.5	3"	1" NPT
55Q/SQE-320	0.75	230	1.5-7.5	3"	1" NPT
55Q/SQE-360	1.0	230	1.5-7.5	3"	1" NPT
55Q/SQE-410	1.0	230	1.5-7.5	3"	1" NPT
55Q/SQE-450	1.5	230	1.5-7.5	3"	1" NPT
105Q/SQE-110	0.5	230/115	3-15	3"	1½" NPT
105Q/SQE-160	0.5	230/115	3-15	3"	1½" NPT
105Q/SQE-200	0.75	230	3-15	3"	1½" NPT
105Q/SQE-240	0.75	230	3-15	3"	1½" NPT
105Q/SQE-290	1.0	230	3-15	3"	1½" NPT
105Q/SQE-330	1.5	230	3-15	3"	1½" NPT
155Q/SQE-70	0.5	230/115	4-20	3"	1½" NPT
155Q/SQE-110	0.5	230/115	4-20	3"	1½" NPT
155Q/SQE-150	0.75	230	4-20	3"	1½" NPT
155Q/SQE-180	0.75	230	4-20	3"	1½" NPT
155Q/SQE-220	1.0	230	4-20	3"	1½" NPT
155Q/SQE-250	1.0	230	4-20	3"	1½" NPT
155Q/SQE-290	1.5	230	4-20	3"	1½" NPT
225Q/SQE-40	0.5	230/115	7-33	3"	1½" NPT
225Q/SQE-80	0.5	230/115	7-33	3"	1½" NPT
225Q/SQE-120	0.75	230	7-33	3"	1½" NPT
225Q/SQE-160	1.0	230	7-33	3"	1½" NPT
225Q/SQE-190	1.0	230	7-33	3"	1½" NPT
225Q/SQE-220	1.5	230	7-33	3"	1½" NPT
305Q/SQE-40	0.5	230/115	8-42	3"	1½" NPT
305Q/SQE-90	0.75	230	8-42	3"	1½" NPT
305Q/SQE-130	1.0	230	8-42	3"	1½" NPT

Accessories

Product	Part number
CU 300	96422776
CU 301	96436754
Flow sleeve	96037505
Grease	96037562
Flow switch	96022967
Pressure transmitter	96026030

U.S.A.

GRUNDFOS Pumps Corporation
17100 West 118th Terrace
Olathe, Kansas 66061
Phone: +1-913-227-3400
Telefax: +1-913-227-3500

Canada

GRUNDFOS Canada Inc.
2941 Brighton Road
Oakville, Ontario
L6H 6C9
Phone: +1-905 829 9533
Telefax: +1-905 829 9512

Mexico

Bombas GRUNDFOS de Mexico
S.A. de C.V.
Boulevard TLC No. 15
Parque Industrial Stiva
Aeropuerto
Apodaca, N.L. 66600
Mexico
Phone: +52-81-8144 4000
Telefax: +52-81-8144 4010

L-SP-TL-017 R 5/06	US
PRINTED IN USA	